



**KEMEDWARDS**  
SITE SUPPLIES NATIONWIDE

10/08



**UNISTRUT®**

CHANNEL  
SUPPORT

T 01932 754700 F 01932 754754 E [sales@kemedwards.co.uk](mailto:sales@kemedwards.co.uk)

## CHANNEL SUPPORT CONTENTS

CHANNEL	1
COVER STRIP	2
CHANNEL SOCKETS & CHANNEL NUTS	3
STUD NUTS, CHANNEL INSERTS	4
LOW PROFILE SELF DRILLING SCREWS	4
CHANNEL FITTINGS	5-12
QUICK FIT STRAP & VERTICAL SUPPORT	12
LIGHTING SUPPORT	13
CHANNEL TROLLEY ASSEMBLIES	14
CABLE & PIPE CLAMPS, CAST-IN CHANNEL	15
KWIKSTRUT	16-19
RAPID RAIL	20-21

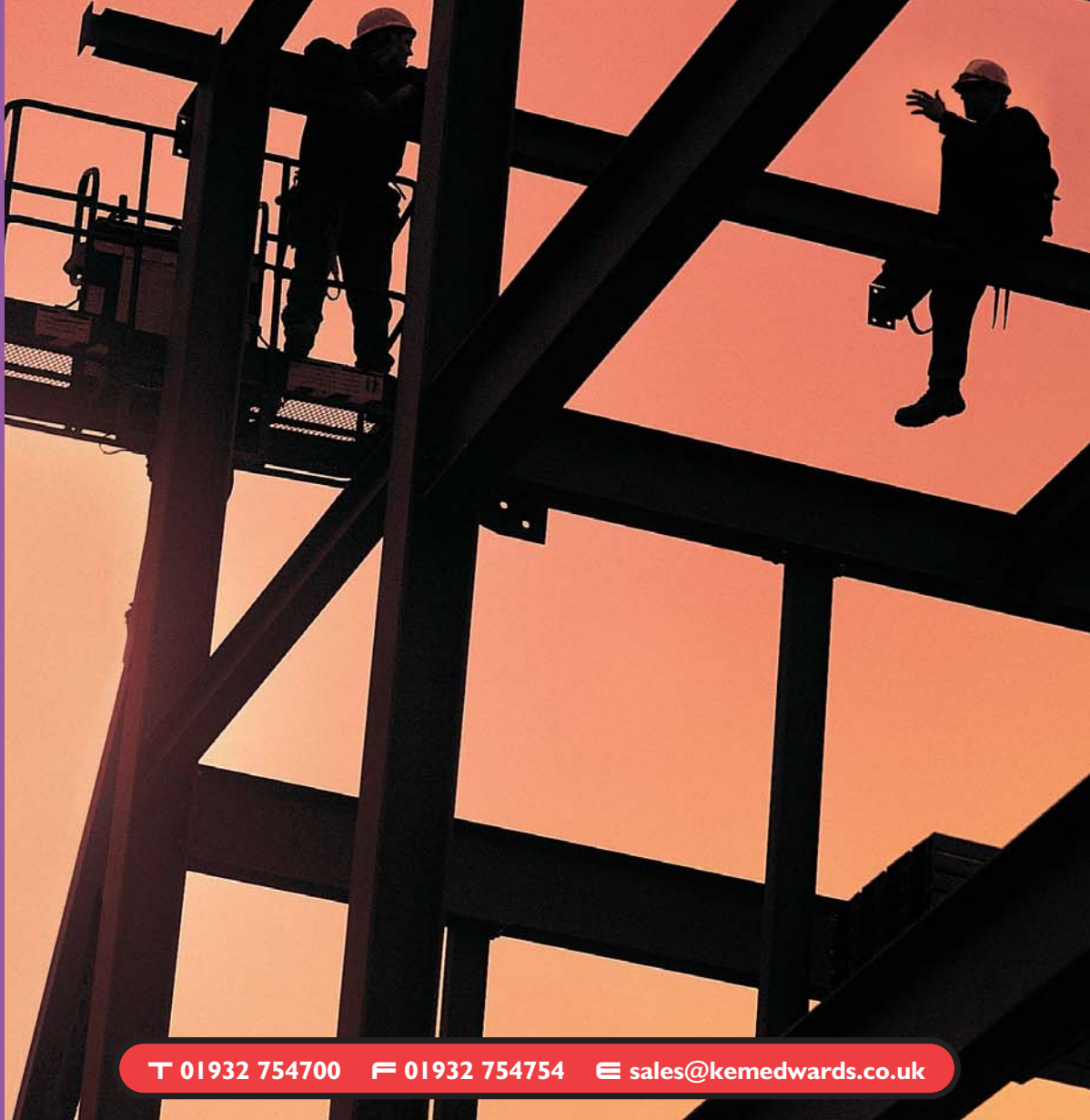

10/08



T 01932 754700 F 01932 754754 E [sales@kemedwards.co.uk](mailto:sales@kemedwards.co.uk)

**CHANNEL****DISCOUNT S**

- Channels offer total flexibility in design and construction of assemblies for framing applications
- Channels are available in plain, continuous slotted and multiple channel combinations
- Standard gauge 2.5mm Light gauge 1.5mm

**Material Availability:**

Standard: Pre-Galvanised Mild Steel BS EN 10147 1992.

Also available: Stainless Steel BS EN 10088-2 Material No.

1.4404(Grade316)

Hot Dipped Galvanised BS EN ISO 1461:1999

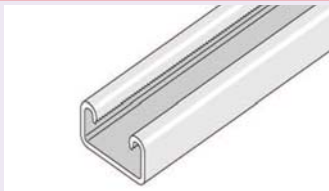
**41X21mm PLAIN**

PRODUCT CODE	MATERIAL	FINISH	UNISTRUT CODE
CHA42P3	Steel	Pre Galvanised	P3300
CHA42P6	Steel	Pre Galvanised	P3300
CHA42GP3	Steel	HDG	P3300
CHA42GP6	Steel	HDG	P3300
CHA42SP3	Stainless Steel		P3300
CHA42SP6	Stainless Steel		P3300

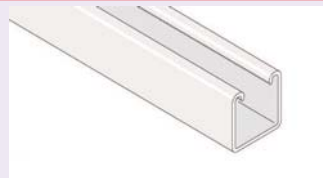
**41X41mm PLAIN**

PRODUCT CODE	MATERIAL	FINISH	UNISTRUT CODE
CHA44P3	Steel	Pre Galvanised	P1000
CHA44P6	Steel	Pre Galvanised	P1000
CHA44GP3	Steel	HDG	P1000
CHA44GP6	Steel	HDG	P1000
CHA44SP3	Stainless Steel		P1000
CHA44SP6	Stainless Steel		P1000

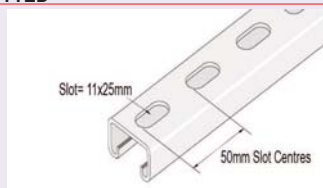
**41X21mm SLOTTED**

PRODUCT CODE	MATERIAL	FINISH	UNISTRUT CODE
CHA42S3	Steel	Pre Galvanised	P3300T
CHA42S6	Steel	Pre Galvanised	P3300T
CHA42GS3	Steel	HDG	P3000T
CHA42GS6	Steel	HDG	P3000T
CHA42SS3	Stainless Steel		P3300T
CHA42SS6	Stainless Steel		P3300T

**41X41mm SLOTTED**

PRODUCT CODE	MATERIAL	FINISH	UNISTRUT CODE
CHA44S3	Steel	Pre Galvanised	P1000T
CHA44S6	Steel	Pre Galvanised	P1000T
CHA44GS3	Steel	HDG	P1000T
CHA44GS6	Steel	HDG	P1000T
CHA44SS3	Stainless Steel		P1001T
CHA44SS6	Stainless Steel		P1001T

**41X41mm 14mm SLOT**

PRODUCT CODE	MATERIAL	FINISH	UNISTRUT CODE
CHA44S3/14	Steel	Pre Galvanised	P1000T
CHA44S6/14	Steel	Pre Galvanised	P1000T
CHA44GS3/14	Steel	HDG	P1000T
CHA44GS6/14	Steel	HDG	P1000T

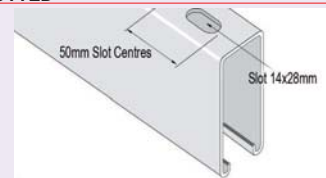
**62X41mm SLOTTED**

PRODUCT CODE	MATERIAL	FINISH	UNISTRUT CODE
CHA64S3	Steel	Pre Galvanised	P5500T
CHA64S6	Steel	Pre Galvanised	P5500T
CHA64GS3	Steel	HDG	P5500T
CHA64GS6	Steel	HDG	P5500T

**82X41mm SLOTTED**

PRODUCT CODE	MATERIAL	FINISH	UNISTRUT CODE
CHA84S3	Steel	Pre Galvanised	P5000T
CHA84S6	Steel	Pre Galvanised	P5000T
CHA84GS3	Steel	HDG	P5000T
CHA84GS6	Steel	HDG	P5000T

**41X21mm BACK TO BACK PLAIN**

PRODUCT CODE	MATERIAL	FINISH	UNISTRUT CODE
CHA42BB3	Steel	Pre Galvanised	P3301
CHA42BB6	Steel	Pre Galvanised	P3301
CHA42SBB3	Stainless Steel		P3301
CHA42SBB6	Stainless Steel		P3301



**41X41mm BACK TO BACK PLAIN**



PRODUCT CODE	MATERIAL	FINISH	UNISTRUT CODE
CHA44BB3	Steel	Pre Galvanised	P1001
CHA44GBB3	Steel	HDG	P1001
CHA44SBB3	Stainless Steel		P1001
CHA44SBB6	Stainless Steel		P1001

**41X21mm BACK TO BACK SLOTTED**



PRODUCT CODE	MATERIAL	FINISH	UNISTRUT CODE
CHA42BBS3	Steel	Pre Galvanised	P3301T
CHA42BBS6	Steel	Pre Galvanised	P3301T
CHA42GBBS3	Steel	HDG	P3301T
CHA42GBBS6	Steel	HDG	P3301T

**41X41mm BACK TO BACK SLOTTED**



PRODUCT CODE	MATERIAL	FINISH	UNISTRUT CODE
CHA44BBS3	Steel	Pre Galvanised	P1001T
CHA44BBS6	Steel	Pre Galvanised	P1001T
CHA44GBBS3	Steel	HDG	P1001T
CHA44GBBS6	Steel	HDG	P1001T
CHA44SBS3	Stainless Steel		P1001T
CHA44SBS6	Stainless Steel		P1001T

**62X41mm BACK TO BACK SLOTTED**



PRODUCT CODE	MATERIAL	FINISH	UNISTRUT CODE
CHA64BBS6	Steel	Pre Galvanised	P5501T
CHA64GBBS3	Steel	HDG	P5501T
CHA64GBBS6	Steel	HDG	P5501T
CHA64BS3	Steel	Pre Galvanised	P5501T

**82X41mm BACK TO BACK SLOTTED**



PRODUCT CODE	MATERIAL	FINISH	UNISTRUT CODE
CHA84BBS6	Steel	Pre Galvanised	P5001T
CHA84GBBS3	Steel	HDG	P5001T
CHA84GBBS6	Steel	HDG	P5001T

**41X21mm LIGHT GAUGE SLOTTED (1.5mm THICK)**

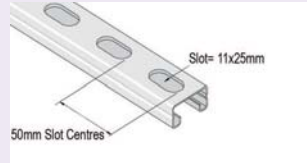

PRODUCT CODE	MATERIAL	FINISH	UNISTRUT CODE
CHA42LS3	Steel	Pre Galvanised	P4000T
CHA42LS6	Steel	Pre Galvanised	P4000T

**41X41mm LIGHT GAUGE SLOTTED (1.5mm THICK)**

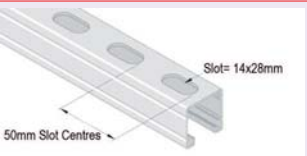

PRODUCT CODE	MATERIAL	FINISH	UNISTRUT CODE
CHA44LS3	Steel	Pre Galvanised	P2000T
CHA44LS6	Steel	Pre Galvanised	P2000T

**41X21mm LIGHT GAUGE PLAIN (1.5mm THICK)**

PRODUCT CODE	MATERIAL	FINISH	UNISTRUT CODE
CHA42LP3	Steel	Pre Galvanised	P4000
CHA42LP6	Steel	Pre Galvanised	P4000

**41X41mm LIGHT GAUGE PLAIN (1.5mm THICK)**

PRODUCT CODE	MATERIAL	FINISH	UNISTRUT CODE
CHA44LP3	Steel	Pre Galvanised	P2000
CHA44LP6	Steel	Pre Galvanised	P2000

**COVER STRIP**

**DISCOUNT B**

**CHANNEL COVER STRIP 3mtr LENGTHS**

PRODUCT CODE	DESCRIPTION	UNISTRUT CODE
CHAGCS	Galvanised.	P1184F
CHAPCSB	Black PVC.	P1184P
CHAPCSW	White PVC.	P1184P

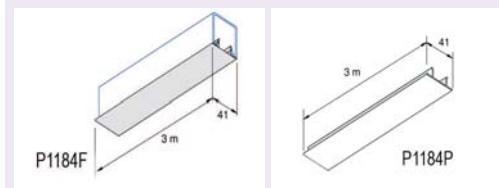

**CHANNEL SOCKETS**

**DISCOUNT B**

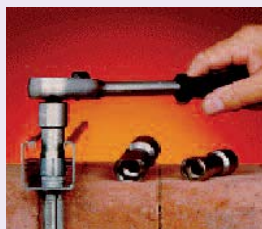

PRODUCT CODE	DESCRIPTION
CHA10S	for M10 bolts.
CHA12S	for M12 bolts.
CHA10S21	for M10 bolts.

**TRAPEZE SUSPENSION HANGER**

**DISCOUNT J**



**Time Saving!**



- makes trapeze pre-assembly an easy option
- trapeze installation can now be one man operation
- provides ability to height adjust with ease up to 30mm
- eliminates the need for strut grid
- can be used with either M8 or M10 studding
- 340kg SWL per 2 fixings
- can also be used as strut suspension/height adjusting bracket
- can be pre or post- fixed

PRODUCT CODE	MATERIAL	FINISH
5996793810	Steel	Bright Zinc Plated BZP

**CHANNEL NUTS**

**DISCOUNT O**

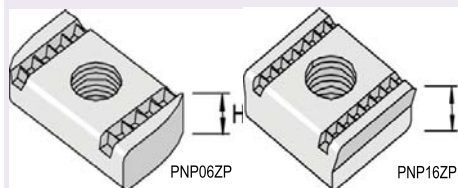
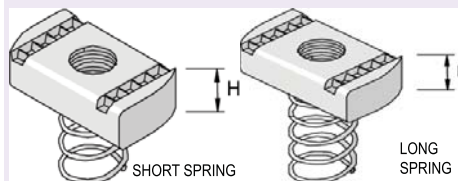
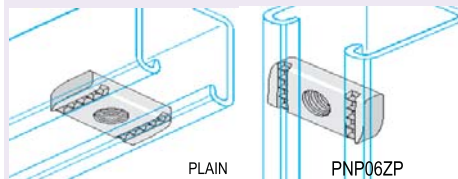

**BZP TO BS 3382 PART 2 1961 CLEAR PASSIVATED**

PRODUCT CODE	SIZE	CHANNEL NUT TYPE	H (mm)	EQUIVALENT UNISTRUT CODE
NUT4CP	M4	Plain	5	PNP04ZP
NUT4CL	M4	Long Spring	5	PNL04ZP
NUT5CP	M5	Plain	5	PNP05ZP
NUT5CS	M5	Short Spring	5	PNS05ZP
NUT5CL	M5	Long Spring	5	PNL05ZP
NUT6CP	M6	Plain	6.5	PNP06ZP
NUT6CS	M6	Short Spring	6.5	PNS06ZP
NUT6CL	M6	Long Spring	6.5	PNL06ZP
NUT8CP	M8	Plain	8	PNP08ZP
NUT8CS	M8	Short Spring	8	PNS08ZP
NUT8CL	M8	Long Spring	8	PNL08ZP
NUT10CP	M10	Plain	9	PNP10ZP
NUT10CS	M10	Short Spring	9	PNS10ZP
NUT10CL	M10	Long Spring	9	PNL10ZP
NUT12CP	M12	Plain	12	PNP12ZP
NUT12CS	M12	Short Spring	12	PNS12ZP
NUT12CL	M12	Long Spring	12	PNL12ZP
NUT16CP	M16	Plain	12	PNP16ZP

**HOT DIP GALVANISED TO BS EN 1461:1999**

PRODUCT CODE	SIZE	CHANNEL NUT TYPE	H (mm)	EQUIVALENT UNISTRUT CODE
NUT6CPG	M6	Plain	6.5	PNP06H
NUT8CPG	M8	Plain	8	PNP08H
NUT8CSG	M8	Short Spring	8	PNS08H
NUT8CLG	M8	Long Spring	8	PNL08H
NUT10CPG	M10	Plain	9	PNP10H
NUT10CSG	M10	Short Spring	9	PNS10H
NUT10CLG	M10	Long Spring	9	PNL10H
NUT12CPG	M12	Plain	12	PNP12H
NUT12CSG	M12	Short Spring	12	PNS12H
NUT12CLG	M12	Long Spring	12	PNL12H



**A4 STAINLESS STEEL**

PRODUCT CODE	SIZE	CHANNEL NUT TYPE	H (mm)	EQUIVALENT UNISTRUT CODE
NUT6CLS	M6	Long Spring	6.5	PNL06SS
NUT10CPS	M10	Plain	9	PNP10SS
NUT10CLS	M10	Long Spring	9	PNL10SS
NUT12CPS	M12	Plain	12	PNP12ASS
NUT12CLS	M12	Long Spring	12	PNL12ASS

**STUD NUTS**

**DISCOUNT F**

**BZP TO BS 3382 PART 2 1961**

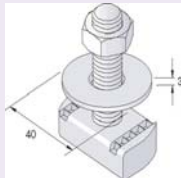

PRODUCT CODE	SIZE (mm)	UNISTRUT CODE
NUT830CS	M8X30	M8X30SN
NUT840CS	M8X40	M8X40SN
NUT850CS	M8X50	M8X50SN
NUT860CS	M8X60	M8X60SN
NUT875CS	M8X75	M8X75SN
NUT8100CS	M8X100	M8X100SN
NUT1030CS	M10X30	M10X30SN
NUT1040CS	M10X40	M10X40SN
NUT1050CS	M10X50	M10X50SN
NUT1060CS	M10X60	M10X60SN
NUT1075CS	M10X75	M10X75SN
NUT10100CS	M10X100	M10X100SN

**CHANNEL INSERTS**

**DISCOUNT M**



• channel inserts allow quick and direct fix of cable containment products to Channel ('Unistrut') Support without the need for Channel Nuts

PRODUCT CODE	LENGTH (mm)
CHA44INS180	180
CHA44INS200	200
CHA44INS250	250
CHA44INS300	300
CHA44INS380	380
CHA44INS630	630
CHA44INS950	950
CHA44INS1100	1100
CHA44INS1200	1200



**LOW PROFILE SELF DRILLING SCREWS**

**DISCOUNT M**



- self drills/taps and clamps securely in one simple operation
- no pre-drilling
- no nuts or bolts
- no spanners
- no wasted time!

PRODUCT CODE	SIZE (mm)
OBXSTD48X16	4.8X16
OBXHD55X20	5.5X20
OBXHD55X40	5.5X40

**POINT CAP**



PVC cap to cover drill trips of metal screws  
 • prevents chafing or damage to cables in trunking etc

PRODUCT CODE  
 OXBPOINTCAP

**CUT & FINISHED LENGTHS SLOTTED CHANNEL**



PRODUCT CODE	SIZE (mm)	LENGTH (mm)	SUITS SINGLE
CHA42S150	41X21	150	
CHA42S200	41X21	200	
CHA42S250	41X21	250	150mm tray/trunking
CHA42S300	41X21	300	
CHA42S350	41X21	350	
CHA42S400	41X21	400	200mm ladder
CHA42S450	41X21	450	300mm tray/trunking
CHA42S500	41X21	500	300mm ladder
CHA42S600	41X21	600	400mm basket
CHA42S700	41X21	700	450mm ladder/tray
CHA42S750	41X21	750	
CHA42S1000	41X21	1000	
CHA42S2500	41X21	2500	
CHA44S200	41X41	200	
CHA44S250	41X41	250	150mm tray/trunking
CHA44S300	41X41	300	
CHA44S350	41X41	350	
CHA44S400	41X41	400	200mm ladder
CHA44S450	41X41	450	300mm tray/trunking
CHA44S500	41X41	500	300mm ladder
CHA44S550	41X41	550	
CHA44S600	41X41	600	400mm basket
CHA44S700	41X41	700	450mm ladder/tray
CHA44S750	41X41	750	
CHA44S800	41X41	800	
CHA44S850	41X41	850	
CHA44S900	41X41	900	
CHA44S1000	41X41	1000	
CHA44S1100	41X41	1100	
CHA44S1200	41X41	1200	
CHA44S1300	41X41	1300	
CHA44S1500	41X41	1500	
CHA44S1600	41X41	1600	
CHA44S2000	41X41	2000	
CHA44S2400	41X41	2400	
CHA44S2500	41X41	2500	



## CHANNEL FITTINGS

**DISCOUNT B**

### Applications:

Channel fittings offer total flexibility in design and construction. A support system for mechanical or electrical services, they can be used for a variety of needs, typically for framework, for ceilings, floors and walls, or providing the structural elements to form complex walkways, racking, roof trusses and load bearing modular ceilings

### Materials:

Manufactured to BS 6946

### Finish:

To BSENISO 1461:1999 unless otherwise stated. Other finishes available upon request.

We pursue a policy of continuing improvement in design and performance of products. The right is therefore reserved to vary specifications without notice.

## FLAT FITTINGS

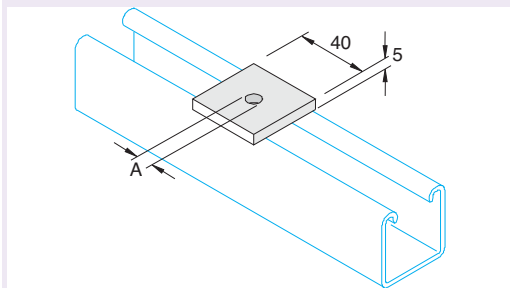

Square Plate Washer

PRODUCT CODE	SIZE (A)	UNISTRUT CODE
WAS6SQ	M6	P1062
WAS8SQ	M8	P1062A
WAS10SQ	M10	P1063
WAS12SQ	M12	P1064

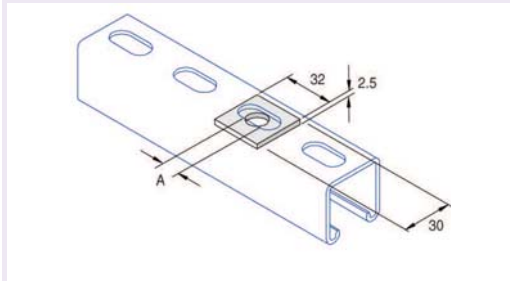

Internal Square Plate Washers

PRODUCT CODE	SIZE (A)	UNISTRUT CODE
BRAF1006	M6	P1063/06
BRAF1008	M8	P1063/08
BRAF10010	M10	P1063/10
BRAF10012	M12	P1063/12

### Bridging Washers

PRODUCT CODE	SIZE
1404130	M12

(Only Available Whilst Stocks Last)

PRODUCT CODE UNISTRUT CODE

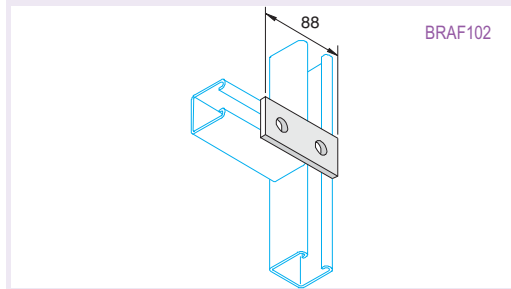

BRAF102 P1065

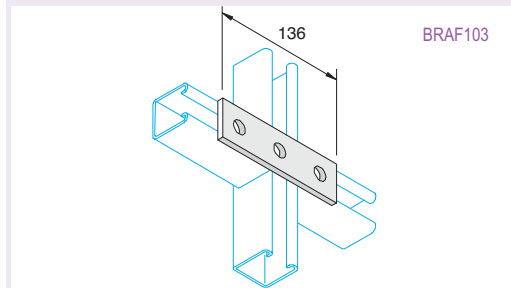

BRAF103 P1066

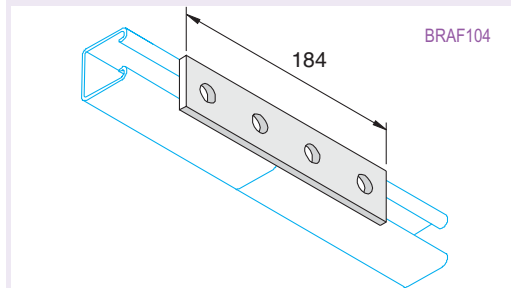

BRAF104 P1067

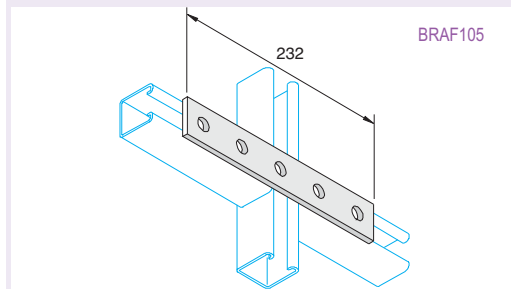

BRAF105 P1941

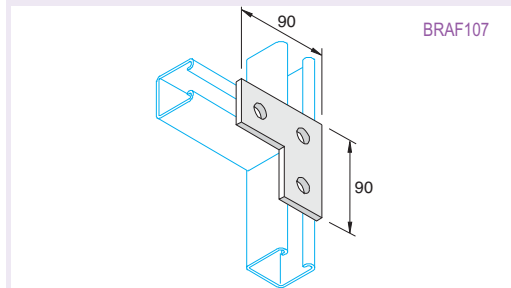

BRAF107 P1036



PRODUCT CODE UNISTRUT CODE

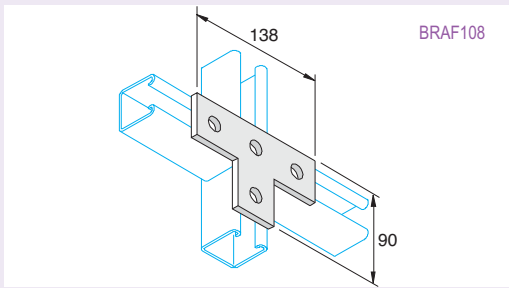

BRAF108 P1031

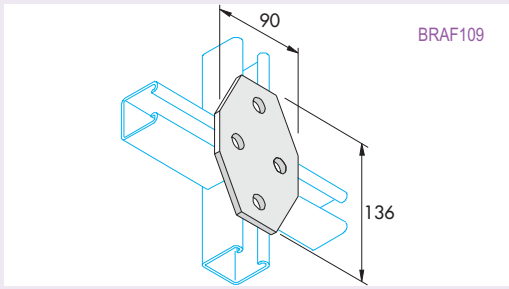

BRAF109 P1580

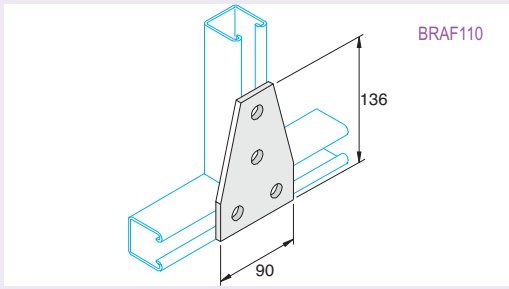

BRAF110 P1358

ANGLE FITTINGS

PRODUCT CODE UNISTRUT CODE

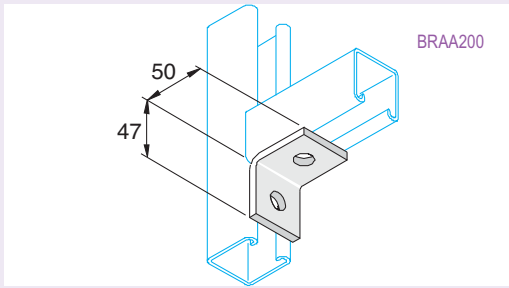

BRAA200 P1026

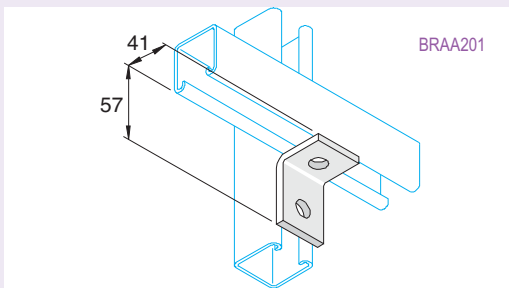

BRAA201 P1068

PRODUCT CODE UNISTRUT CODE

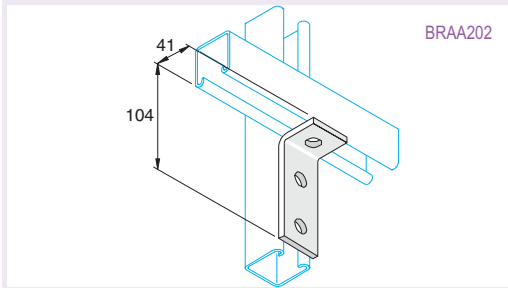

BRAA202 P1326

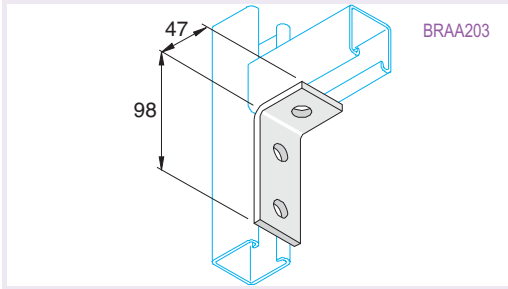

BRAA203 P1346

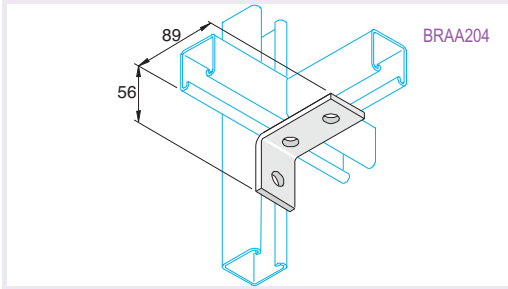

BRAA204 P1458

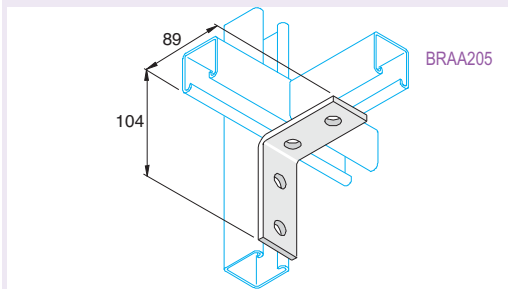

BRAA205 P1325

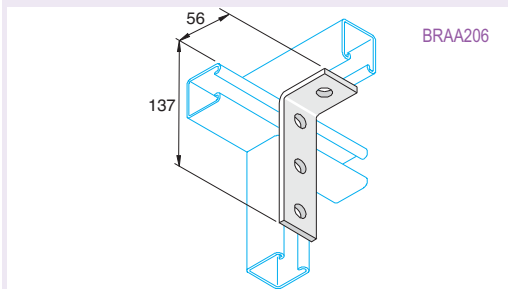

BRAA206 P1278



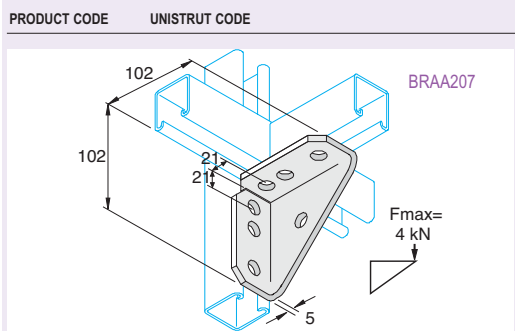

BRAA207 P2484

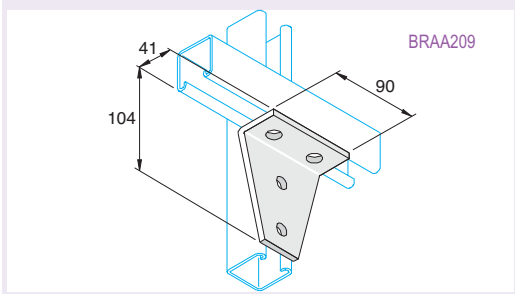

BRAA209 P1359

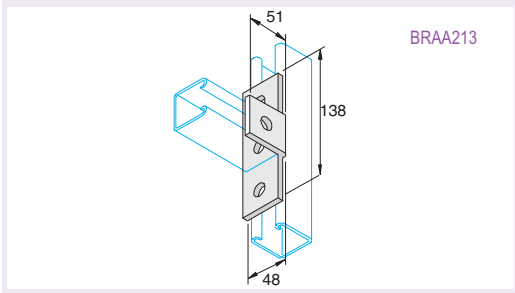

BRAA213 P1033

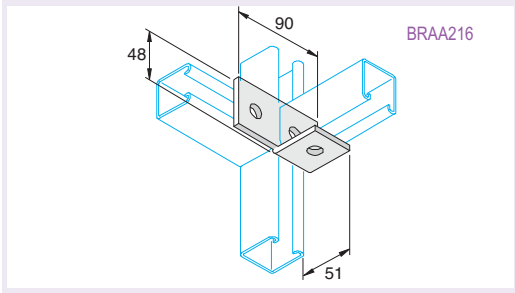

BRAA216 P1037

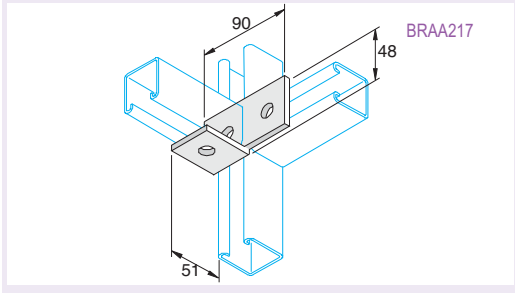

BRAA217 P1038

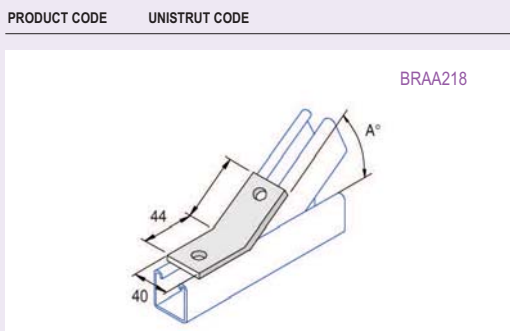

BRAA218 P1546

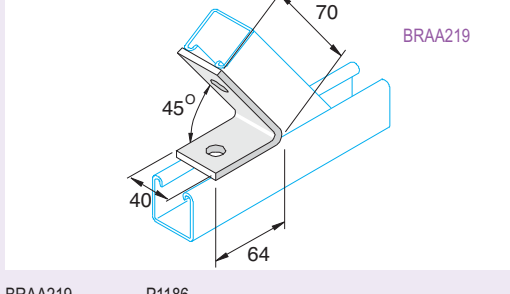

BRAA219 P1186

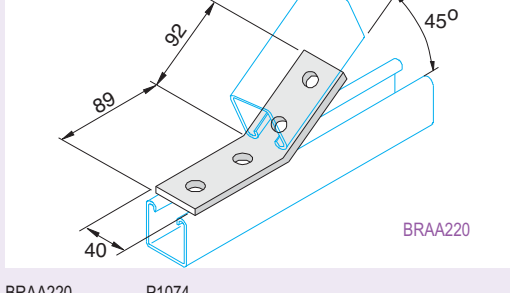

BRAA220 P1074

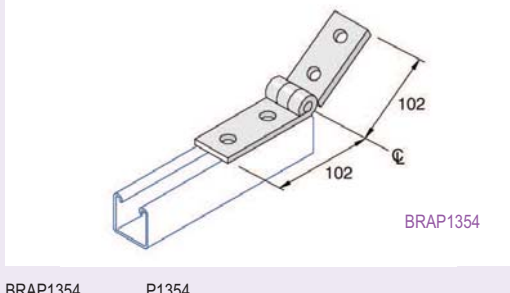

BRAP1354 P1354

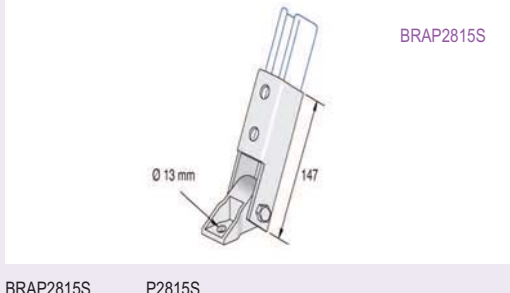

BRAP2815S P2815S



BASE & WING FITTINGS

PRODUCT CODE UNISTRUT/ KWIKSTRUT CODE

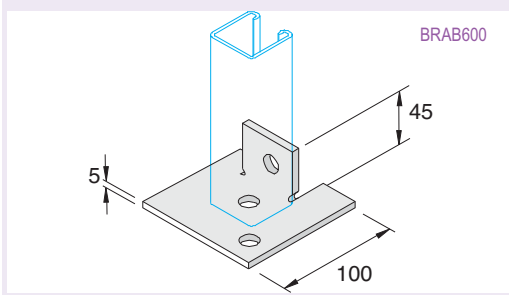

BRAB600 P2072-S2

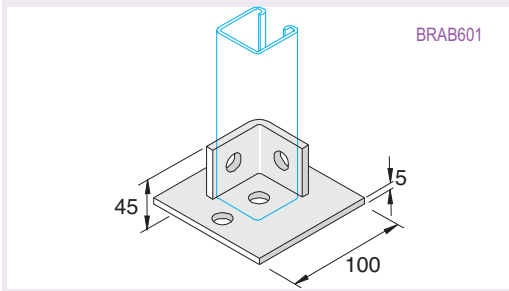

BRAB601 P2072-S1

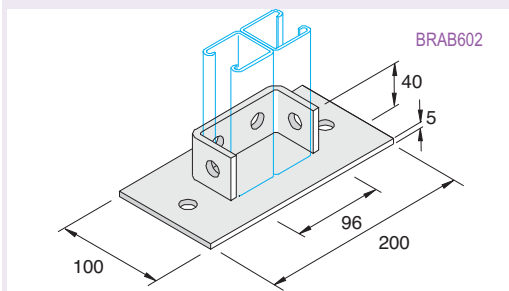

BRAB602 P2073

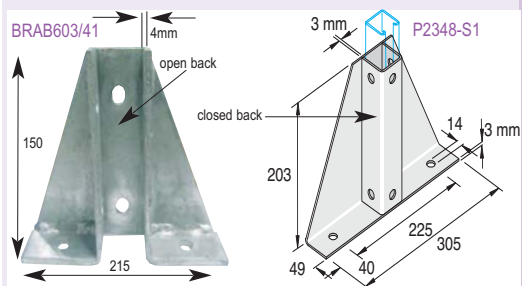

BRAB603/41 P2348-S1

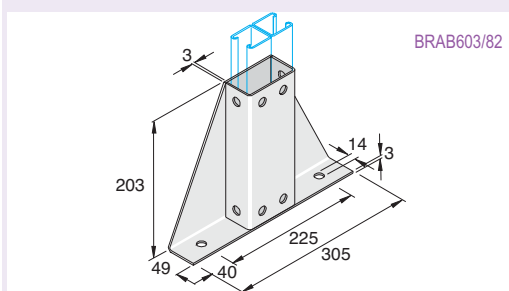

BRAB603/82 P2348-S2

PRODUCT CODE UNISTRUT CODE

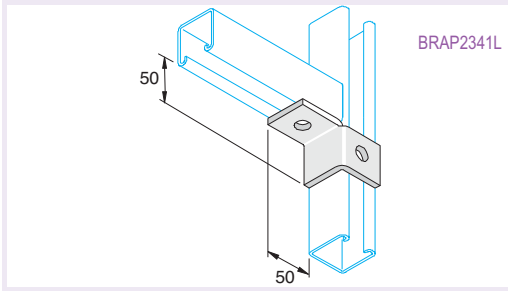

BRAP2341L P2341L

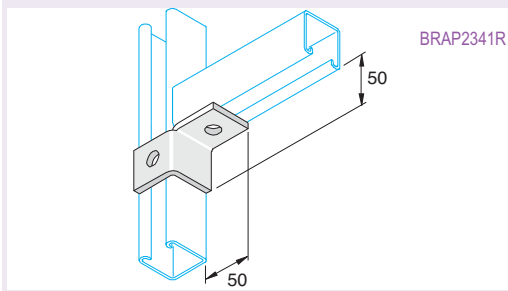

BRAP2341R P2341R

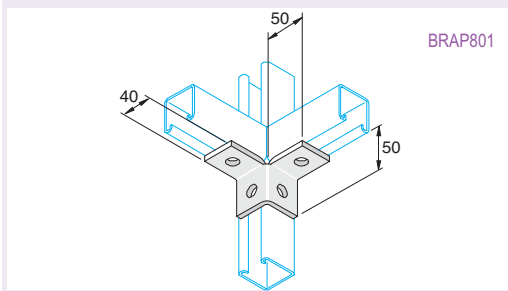

BRAP801 P2223

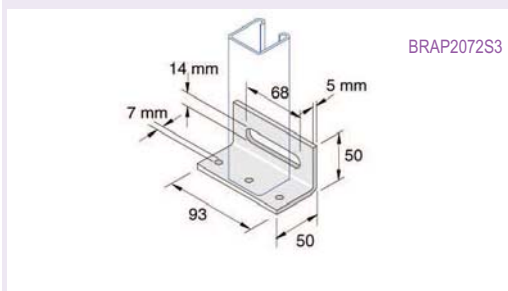

BRAP2072S3 P2072-S3

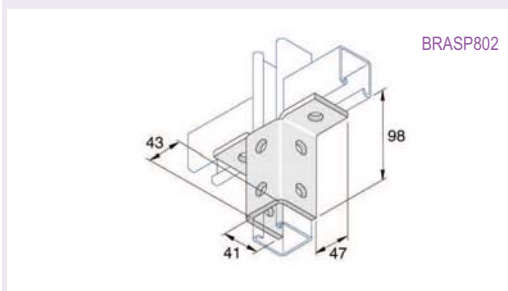

BRASP802 P2346



## U AND Z FITTINGS & COUPLERS

PRODUCT CODE UNISTRUT CODE

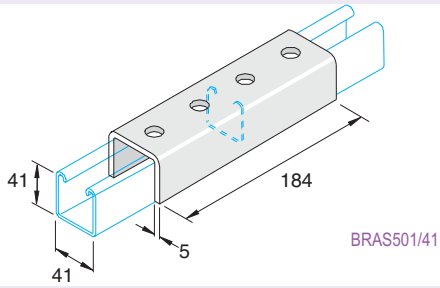

BRAS501/41

BRAS501/41 P1377

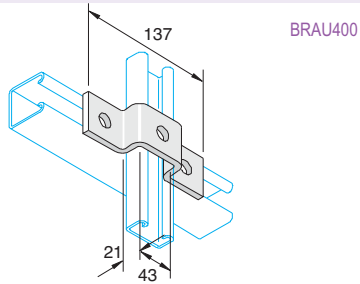

BRAU400

BRAU400 P4047

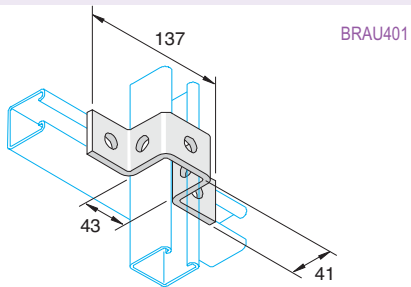

BRAU401

BRAU401 P1047

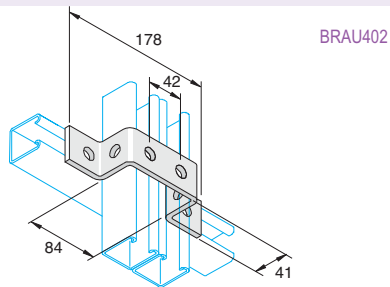

BRAU402

BRAU402 P1043

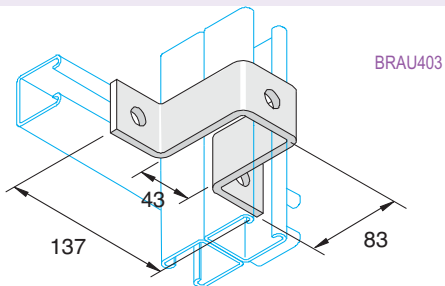

BRAU403

BRAU403 P1737

PRODUCT CODE UNISTRUT CODE

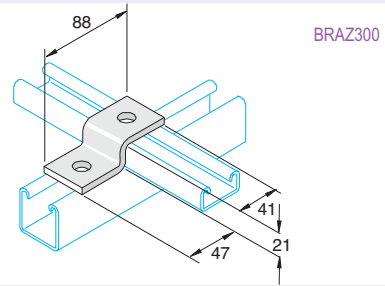

BRAZ300

BRAZ300 P4045

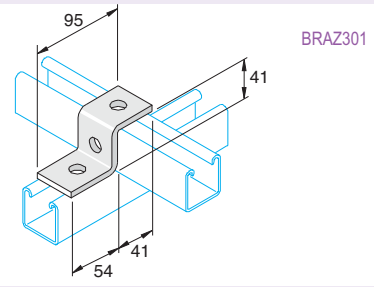

BRAZ301

BRAZ301 P1045

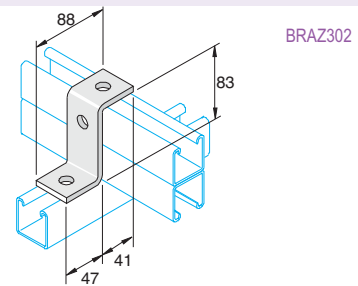

BRAZ302

BRAZ302 P1453

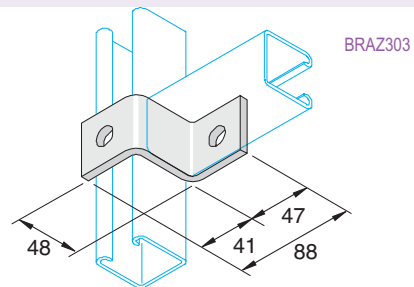

BRAZ303

BRAZ303 P1347

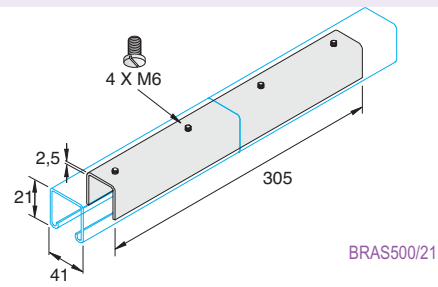

BRAS500/21

BRAS500/21 P1219



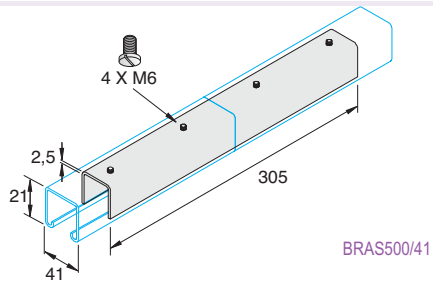

BRAS500/41 P1218

**BEAM CLAMPS**

PRODUCT CODE UNISTRUT CODE

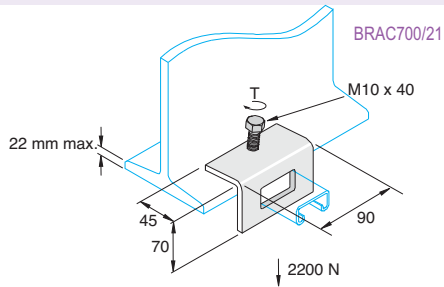

BRAC700/21 P1796A

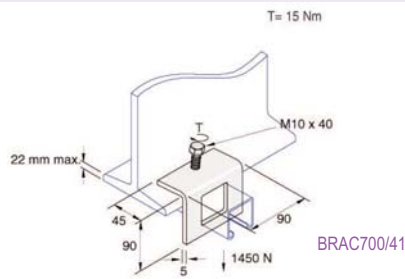

BRAC700/41 P1796

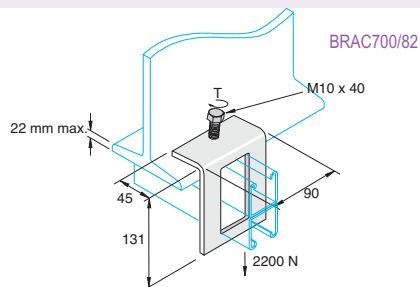

BRAC700/82 P1796B

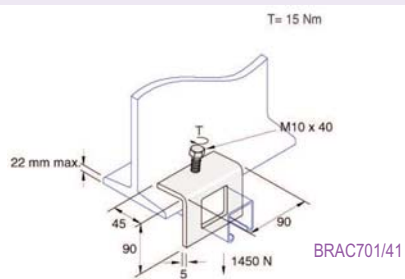

BRAC701/41 P2785

PRODUCT CODE UNISTRUT CODE

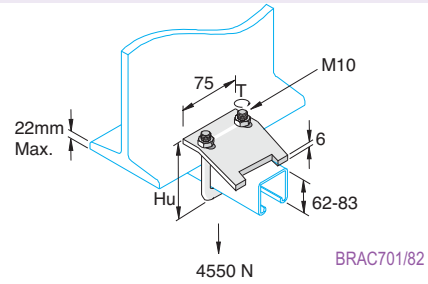

BRAC701/82 P2786

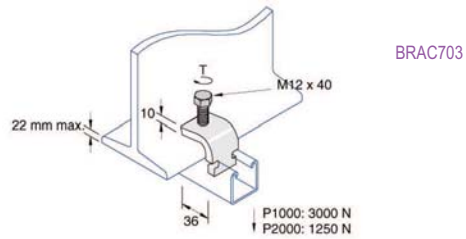

BRAC703 P1386

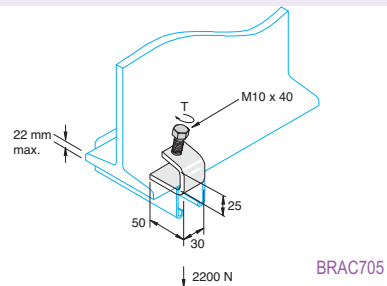

BRAC705 P1272

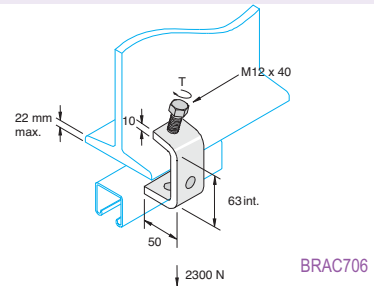

BRAC706 P1271

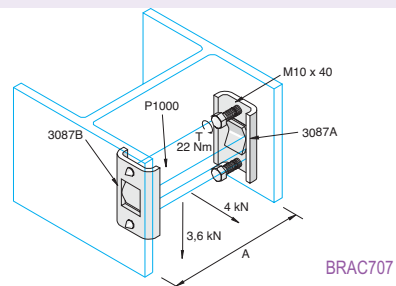

BRAC707 P3087



PRODUCT CODE UNISTRUT CODE

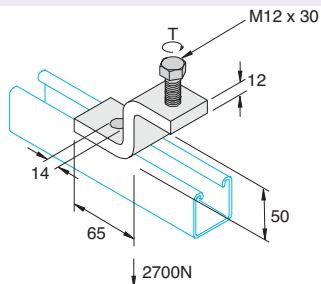

BRAP1983

BRAP1983 P1983

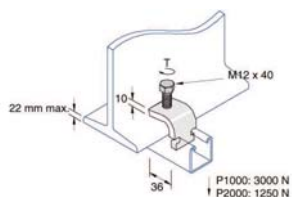

BRAP2489

BRAP2489 P2489

SPARE CONE POINT SET SCREWS



PRODUCT CODE SIZE  
M10X40CP M10X40

CANTILEVER ARMS

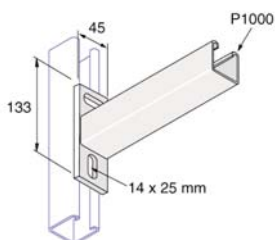

PRODUCT CODE	UNISTRUT CODE	LENGTH (mm)
BRACA4/150	P2663/150	150
BRACA4/300	P2663/300	300
BRACA4/450	P2663/450	450
BRACA4/600	P2663/600	600
BRACA4/750	P2663/750	750

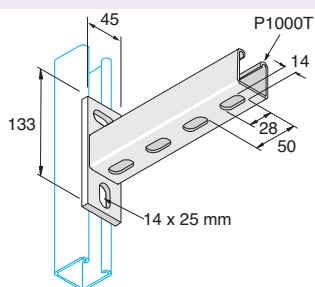

Slotted

PRODUCT CODE	UNISTRUT CODE	LENGTH (mm)
BRACA4/150S	P2663T150	150
BRACA4/300S	P2663T300	300
BRACA4/450S	P2663T450	450
BRACA4/600S	P2663T600	600
BRACA4/750S	P2663T750	750

With top fixing hole and bottom location lug

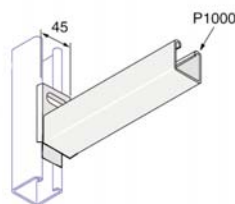

Other combinations and profiles available

PRODUCT CODE	LENGTH (mm)
BRACA7/300	300
BRACA7/450	450
BRACA7/600	600
BRACA7/750	750

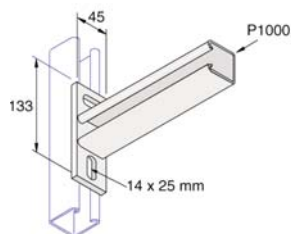

Plain with side opening

PRODUCT CODE	UNISTRUT CODE	LENGTH (mm)
BRACA4/150SO	P2668/150	150
BRACA4/300SO	P2668/300	300
BRACA4/450SO	P2668/450	450
BRACA4/600SO	P2668/600	600

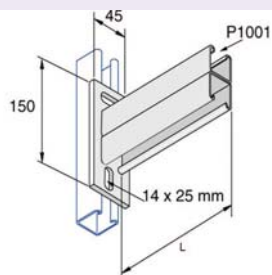

Double Cantilever Arms

PRODUCT CODE	UNISTRUT CODE	LENGTH (mm)
BRACA5/450	P2665/450	450
BRACA5/600	P2665/600	600
BRACA5/750	P2665/750	750
BRACA5/900	P2665/900	900



PLASTIC END CAPS

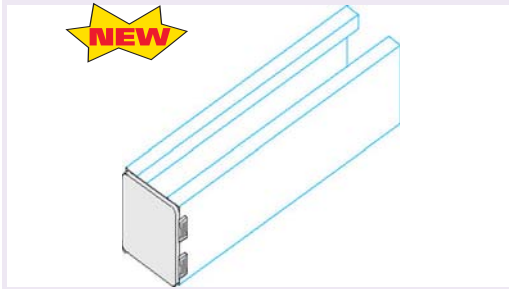

PRODUCT CODE	SIZE (mm)	UNISTRUT CODE	COLOUR
CHA42ECB	41X21	P3/4240	Black
CHA42ECW	41X21	P3/4240	White
CHA42ECR	41X21	P3/4240	Red
CHA44ECB	41X41	P1/2240	Black
CHA44ECW	41X41	P1/2240	White
CHA44ECR	41X41	P1/2240	Red

LSF

PRODUCT CODE	SIZE (mm)	COLOUR
CHA42ECBLSF	41X21	Black
CHA44ECBLSF	41X41	Black

QUICK FIT STRAP

DISCOUNT

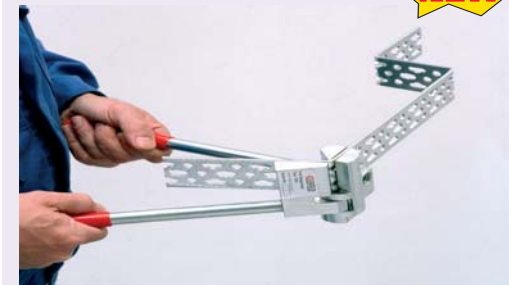

Flexible fixing strap for multiple applications on site

- for on-site fabrication of bespoke bracketry
- 3 separately shaped holes for flexible fixing
- bends up to 135°
- ideal for risers where space is limited
- ideal for FM or retrofit applications
- supplied in 2m lengths

PRODUCT CODE  
85-99607

**NOT SURE EXACTLY  
WHAT YOU NEED?  
CALL THE  
TECHNICAL TEAM  
01932 754700**

VERTICAL SUPPORTS

NEW PRODUCT

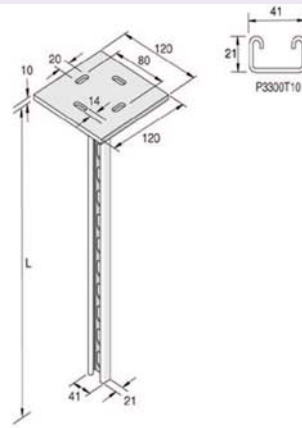

Single Channel 41X21

PRODUCT CODE	LENGTH (mm)	UNISTRUT CODE
VSL/500	500	HLB/500
VSL/750	750	HLB/750
VSL/1000	1000	HLB/1000
VSL/1250	1250	HLB/1250

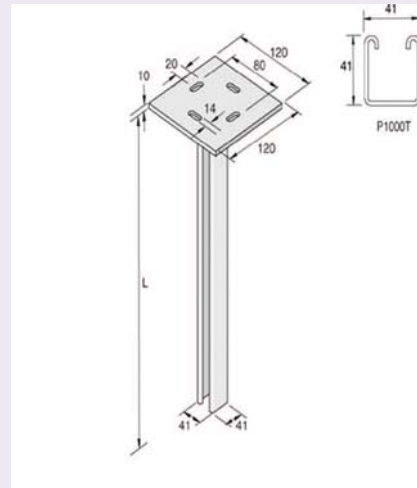

Single Channel 41X41

PRODUCT CODE	LENGTH (mm)	UNISTRUT CODE
VSM/500	500	HBM/500
VSM/750	750	HBM/750
VSM/1000	1000	HBM/1000
VSM/1250	1250	HBM/1250

BROWSE THE WEB  
[www.kemedwards.co.uk](http://www.kemedwards.co.uk)



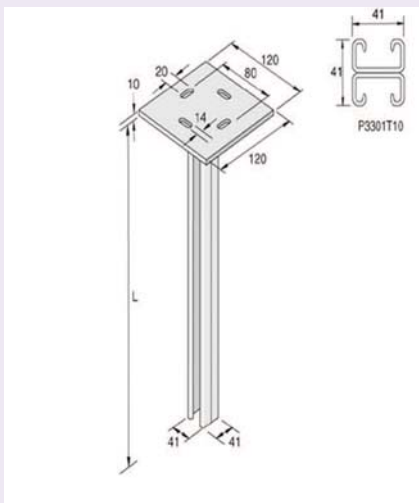

Double Channel 41X21

PRODUCT CODE	LENGTH (mm)	UNISTRUT CODE
VSLD/500	500	HBLD/500
VSLD/750	750	HBLD/750
VSLD/1000	1000	HBLD/1000
VSLD/1250	1250	HBLD/1250
VSLD/1500	1500	HBLD/1500
VSLD/2000	2000	HBLD/2000

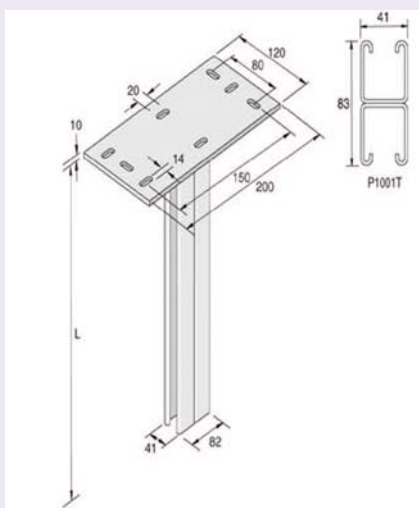

Double Channel 41X41

PRODUCT CODE	LENGTH (mm)	UNISTRUT CODE
VSH/500	500	HBH/500
VSH/750	750	HBH/750
VSH/1000	1000	HBH/1000
VSH/1250	1250	HBH/1250
VSH/1500	1500	HBH/1500
VSH/2000	2000	HBH/2000

LIGHTING SUPPORTS

PRODUCT CODE UNISTRUT CODE

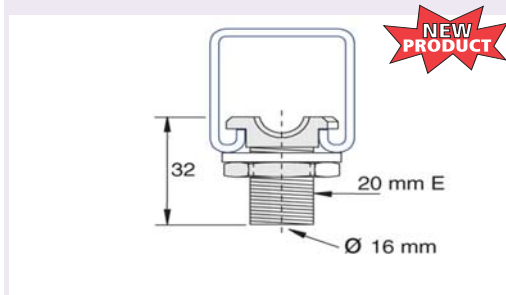

LSP2540M20 P2540M20

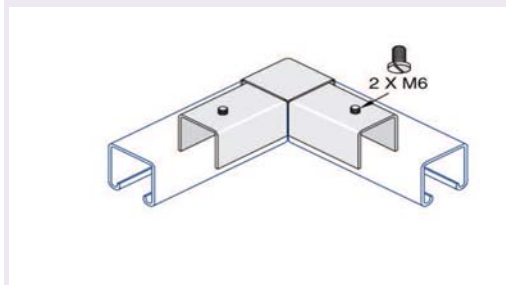

LSP2902 P2902

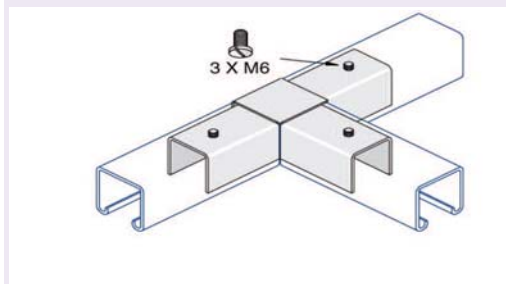

LSP2901 P2901

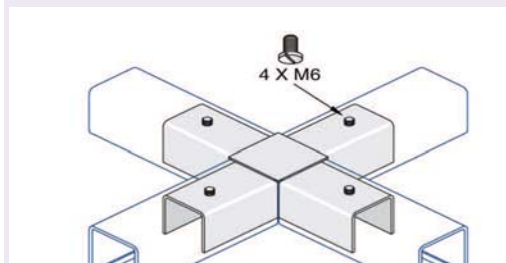

LSP2903 P2903

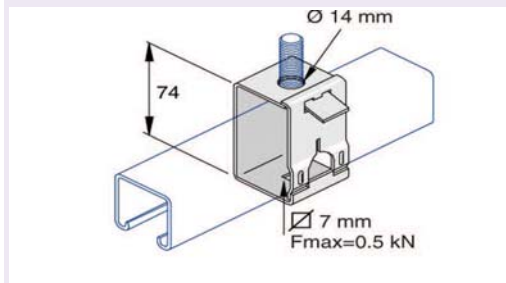

LSP2855 P2855



CHANNEL TROLLEY ASSEMBLIES



PRODUCT CODE UNISTRUT CODE

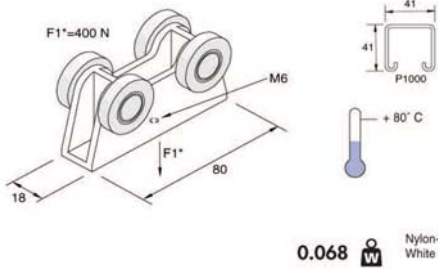

LSP2750/1 P2750/1

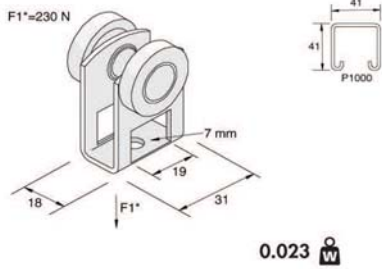

LSP2749 P2749

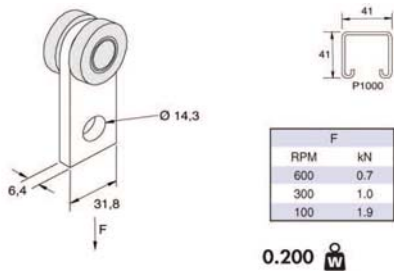

LSP2949 P2949

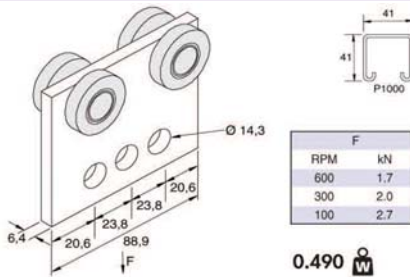

LSP2950 P2950

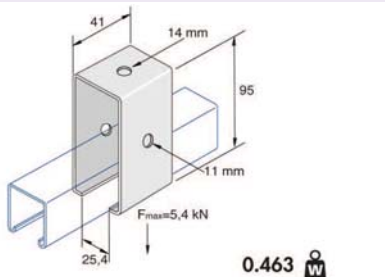

LSP1834 P1834

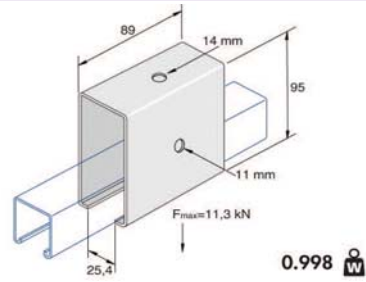

LSP1834A P1834A

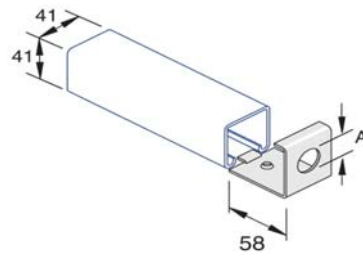

PRODUCT CODE UNISTRUT CODE  
LSP2521/50 P2521/50  
LSP2521/75 P2521/75

UNISTRUT®



The Original Unistrut  
Accept No Substitutes!

Support Solutions  
Cable Management  
Pipe Support



For complete Cable Management Solutions count on Unistrut cable tray, cable ladder and innovative basket tray products. Supported by the Original Unistrut system. for expert quality-assurance.

Remember we invented it!

Visit us at: [www.unistrut.co.uk](http://www.unistrut.co.uk)  
Working in partnership with



Unistrut Limited is a company registered in England and Wales. Registered Number 1056870. Registered Office Victoria Road, Leeds, LS11 5JQ.



## CABLE AND PIPE CLAMPS

**DISCOUNT B**

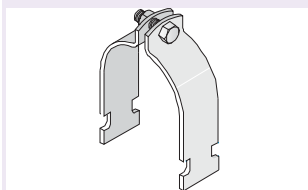

For clamping cable and pipework directly onto channel at 90°.

PRODUCT CODE	CLAMP CAPACITY MIN (mm)	CLAMP CAPACITY MAX (mm)
--------------	-------------------------	-------------------------

M1108	8.7	10.3
M1109	10.3	12.7
M1110	11.9	13.5
M1111	13.5	14.3
M1112	14.3	16.7
M1113	15.9	18.3
M1114	18.3	20.6
M1115	19	21.4
M1116	21.4	25.4
M1117	25.4	27.8
M1118	27	30.2
M1119	30.2	33.8
M1120	31.8	35.9
M1121	34.9	39.7
M1122	39.7	42.9
M1123	42.9	46.8
M1124	46.8	50.8
M1125	48.4	52.4
M1126	52.4	58.7
M1127	58.7	63.5
M1128	63.5	68.3
M1129	68.3	73
M1130	73	79.4
M1131	76.2	82.6
M1132	82.6	88.1
M1133	88.1	95.2
M1134	95.2	100
M1135	100	106.4
M1136	106.4	111.1
M1137	111.1	120.7
M1138	120.7	129.4
M1139	129.4	138.1
M1140	138.1	149.2
M1141	149.2	161.9
M1142	161.9	174.6
M1143	174.6	182.6
M1144	182.6	190.5
M1145	190.5	203.2
M1146	203.2	212.7
M1147	212.7	225.4
M1148	225.4	238.1
M1149	238.1	250.8
M1150	250.8	263.5
M1151	263.5	276.2
M1152	276.2	288.9
M1153	288.9	301.6
M1154	301.6	314.3
M1155	314.3	327

## CAST-IN CHANNEL

**DISCOUNT B**

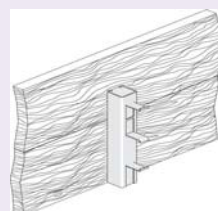

Cast-in channel is manufactured from standard Unistrut section and can be installed in floors, walls and ceilings, for the support of all types of piping, conduit, cable support and other industrial equipment.

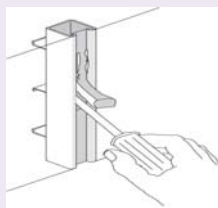

Cast-in channel is available pre-filled with an easily removable foam; this is to prevent the ingress of grout or cement.

Spring nuts can be inserted anywhere along the length of the channel, providing a means of attachment for all kinds of fittings or rods where required.

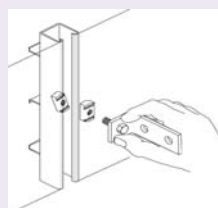

Supplied in pre-galvanised as standard, hot dip galvanised and stainless steel finishes are also available. Please contact the Sales Office on 01932 754700 for details

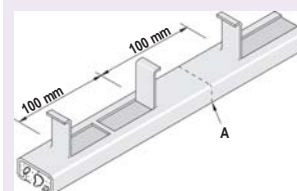
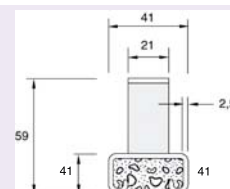

Designed to accommodate M6, M8, M10, and M12 fixings. Normal cutting positions are between lugs as indicated (A). Supplied in 6 metre lengths. Non-standard lengths can be supplied in increments of 200mm.

PRODUCT CODE	SIZE (mm)	UNISTRUT CODE
--------------	-----------	---------------

CHA42CI6 41X21 P3370

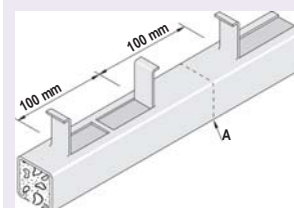
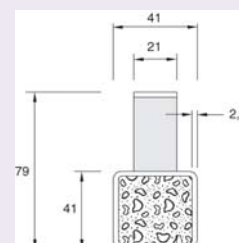

Designed to accommodate M6, M8, M10, M12 and M16 fixings. Normal positions are between lugs as indicated (A). Supplied in 6 metre lengths, non-standard lengths can be supplied in increments of 200mm.

PRODUCT CODE	SIZE (mm)	UNISTRUT CODE
--------------	-----------	---------------

CHA44CI6 41X41 P3270



**KWIKSTRUT**

**DISCOUNT B**



Prefabricated bracketry designed to reduce installation time by over 40%.  
 Brackets are supplied with pre-assembled spring nuts and bolts  
 Brackets are fixed by a quick turn through 90 degrees  
 Easy tightening of the nuts and bolts  
 Fewer components aid simpler design and easier ordering  
 Material:  
 Supplied in electro zinc plated as standard.  
 Hot dipped galvanised to EN ISO 1461:1999 on request

**FLAT CHANNEL SADDLE - QCN**



PRODUCT CODE	SIZE
1390630	M6
1390830	M8
1391031	M10
1391230	M12

**CHANNEL NUTS - QFNH**

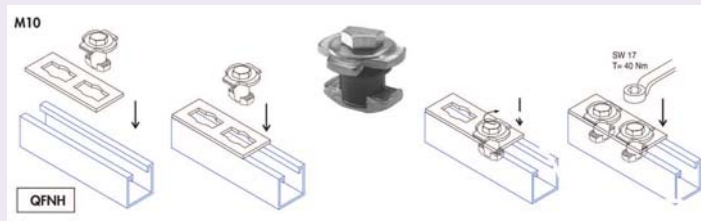

A universal channel nut to fit all sizes of channel. Easy installation, adjustment and removal.

PRODUCT CODE	SIZE
1391016	M10

**QRN**



No more need for a flat washer and channel nut, this is the quickest and most cost effective method of installing studding.

PRODUCT CODE	SIZE
1390821	M8
1391020	M10
1391220	M12



QTB

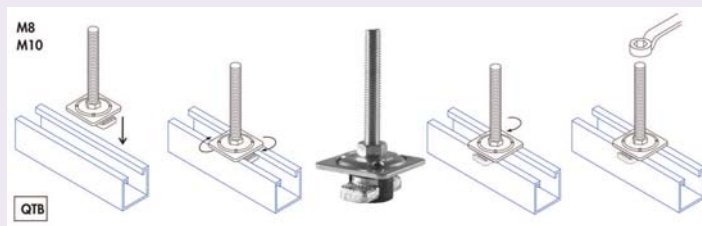

Like the QRN but with pre-installed studding. Single part making ordering and stock holding simple.

PRODUCT CODE	SIZE	LENGTH (mm)
1390258	M8	25
1390508	M8	50
1391008	M8	100
1391508	M8	150
1392008	M8	200
1390253-	M10	25
1390500	M10	50
1391000	M10	100
1391500	M10	150
1392000	M10	200
1390252	M12	25
1390502	M12	50
1391002	M12	100
1391502	M12	150
1392002	M12	200



**KWIKSTRUT BRACKETS**

Quick construction of all support bracket needs through extensive range of pre-fabricated couplers, joiners and angle brackets.

**2 HOLE FLAT PLATE**



PRODUCT CODE	DESCRIPTION
1390147	2 Hole plate.

**3 HOLE FLAT PLATE**



PRODUCT CODE	DESCRIPTION
1390146	3 Hole tee.

**QEN**

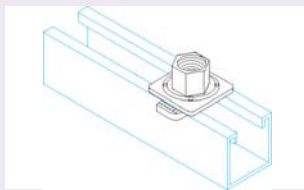

PRODUCT CODE	SIZE
1391620	M16

**QFA FLAT ANGLE 90°**

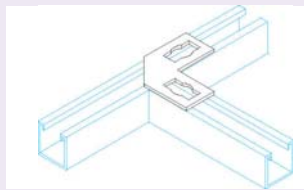

PRODUCT CODE
1390125

**QFAZ INT ANGLE 90°**

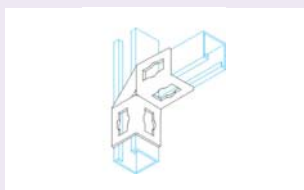

PRODUCT CODE	DESCRIPTION
1399055	2+2 Hole
1399065	4+4 Hole

**QCA WALL FIX WASHER**

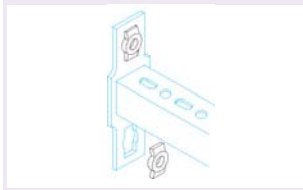

PRODUCT CODE	SIZE
1391065	M8
1391265	M10
1390865	M12

**QFA135 INTERNAL ANGLE 135°**

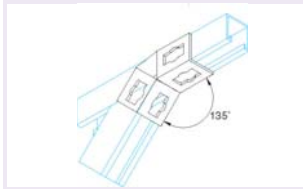

PRODUCT CODE	DESCRIPTION
1393555	2+2 Hole
1393565	2+4 Hole

**QFFA INTERNAL ANGLE 90°**

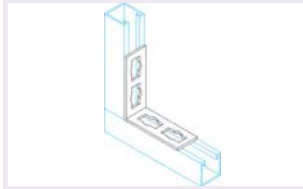

PRODUCT CODE	DESCRIPTION
1399025	1+1 Hole
1399035	1+2 Hole
1399045	2+2 Hole

**QFFA135 INTERNAL ANGLE 135°**

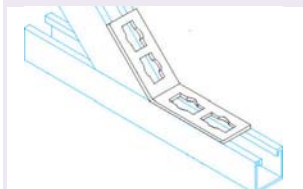

PRODUCT CODE	DESCRIPTION
1393535	1+2 Hole
1393545	2+2 Hole

**QFFT ANGLE BRACKET**

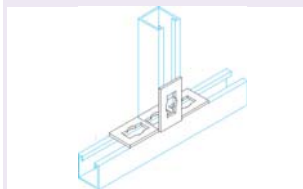

PRODUCT CODE
1390115

**QFT ANGLE BRACKET**

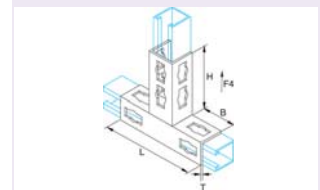

PRODUCT CODE
1394118

**QFFA45 INTERNAL ANGLR BRACKET**

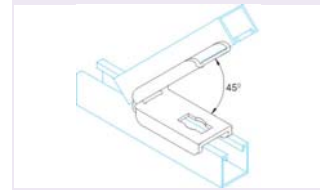

PRODUCT CODE
1394525

**QFU 41MM U FITTING**

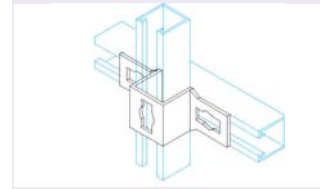

PRODUCT CODE
1394138

**3-WAY FITTING**

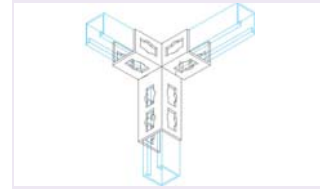

PRODUCT CODE	DESCRIPTION
1394111	3-Way Fitting LH
1394112	3-Way Fitting RH

**QFCD 4-WAY FITTING**

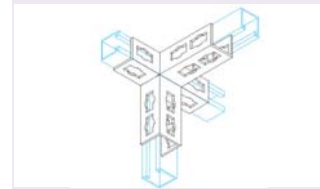

PRODUCT CODE
1394128



**QFX ANGLE BRACKET**

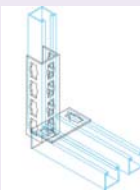

QFX Angle Bracket

PRODUCT CODE  
1391392

**QFDC STRAIGHT FITTING**

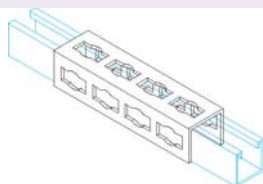

PRODUCT CODE  
1394148

**ANGLE BRACKETS**

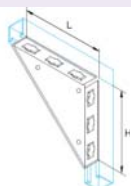

QKON Angle Brackets

PRODUCT CODE	DESCRIPTION
1390155	195x195mm
1390165	210x155mm

**QB INTERNAL ANGLE 90° BASE PLATE**



PRODUCT CODE  
1391391

**ROD CONNECTION QFMP**

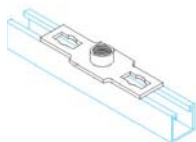

Where high loadings are required this is the quick, effective rod connection fitting.

PRODUCT CODE	SIZE
1390825	M8
1391025	M10
1391225	M12
1391625	M16

**QFFC**

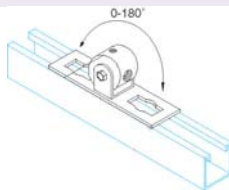

PRODUCT CODE	SIZE
1390135	M8/M10/M12

**ADJUSTABLE ANGLE FITTINGS**

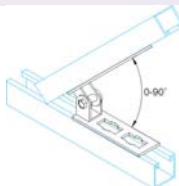

PRODUCT CODE	DESCRIPTION
1390185	Inline Hinge
1390195	Offset Hinge

**CHANNEL BASE FITTINGS**

PRODUCT CODE	UNISTRUT/ KWIKSTRUT CODE
--------------	-----------------------------

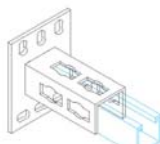

1394158	QB41
---------	------

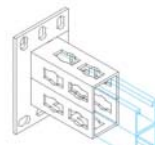

1394458	QB82
---------	------

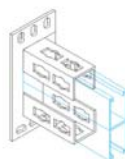

1396658	QB124
---------	-------

**CANTILEVER ARMS QLCA**

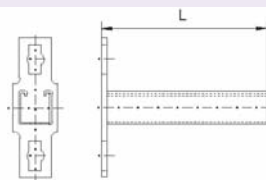

PRODUCT CODE	(L)
1394119	200
1394129	250
1394139	350
1394149	450

**QBF**

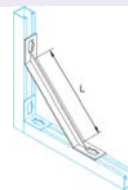

PRODUCT CODE	(L)
1393007	300
1394007	400
1395007	500
1396007	600



**RAPID RAIL**

**DISCOUNT** M



**WM 15 RAPIDRAIL**



C-Profile rapid rail with continuous perforation  
Quick fixing  
Pre-assembled fixings  
Low labour cost

PRODUCT CODE	W (mm)	H (mm)	L (M)
6505015	30	20	2
6505615	30	20	6

**END CAPS**



PRODUCT CODE  
6566000

**SLIDE NUTS**



PRODUCT CODE	SIZE
6513106	M6
6513108	M8
6513110	M10

**PLAIN SLIDE NUTS**

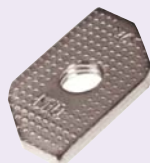

PRODUCT CODE	SIZE
6513006	M6
6513008	M8
6513010	M10

**RAPIDRAIL CONNECTOR**



PRODUCT CODE	LENGTH (mm)
6543001	200

**SLIDE TEE-BOLT ASSEMBLY**



PRODUCT CODE	SIZE
6523802	M8X25
6523803	M8X30
6523804	M8X40
6523805	M8X50
6523810	M8X100
6523002	M10X25
6523003	M10X30
6523004	M10X40
6523005	M10X50
6523006	M10X60
6523007	M10X70
6523008	M10X80
6523009	M10X90
6523010	M10X100

**RAPIDRAIL SWIVEL HANGERS**



PRODUCT CODE	SIZE
6520100	M8X25
6520200	M8X50
6520110	M10X25
6520210	M10X50

**RAPID RAIL 90° RAIL CONNECTORS**



PRODUCT CODE	DESCRIPTION
6584001	longxlong, 2 sides pre-assembled
6584002	longxshort, 2 sides pre-assembled
6584003	shortxshort, 2 sides pre-assembled
6584011	longxlong, 1 side pre-assembled
6584012	longxshort, long pre-assembled

**135° ANGLED CONNECTORS**



PRODUCT CODE	DESCRIPTION
6584051	longxlong, 2 sides pre-assembled
6584052	longxshort, 2 sides pre-assembled
6584053	shortxshort, 2 sides pre-assembled
6584061	longxlong, 1 side pre-assembled
6584062	longxshort, long pre-assembled

**T CONNECTOR**



PRODUCT CODE  
6584090

**X CONNECTOR**



PRODUCT CODE  
6584091

**RAIL CLAMP**



PRODUCT CODE  
6584152

**FABRICATED BACK PLATES**



PRODUCT CODE  
6613200

**RAIL PROPS**



PRODUCT CODE	LENGTH (mm)
6628220	200
6628230	300



**RAIL PRESSURE END PLATE  
ASSEMBLY**



PRODUCT CODE  
6613820

**EXPANSION JOINT**



PRODUCT CODE  
6653310

